

Sealings

For measuring instruments and instrumentation accessories

Model 910.17

Applications

- Sealing of process connections with parallel threads

Special features

- Large selection of materials and sizes
- Versions: Flat sealing ring per EN 837-1 (and similar), WIKA sealing ring and edge sealing ring
- For process connections with/without centring spigot

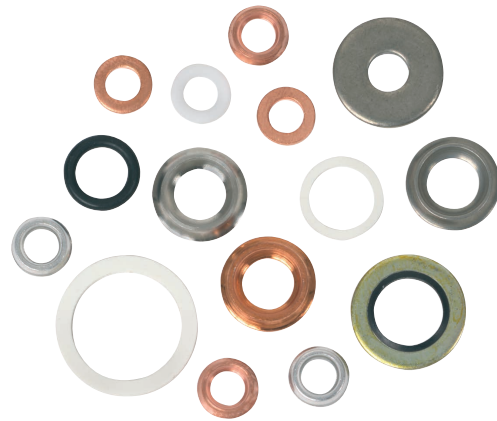

Various versions of model 910.17

Description

The model 910.17 contact sealings sit between the stationary surfaces of a parallel screw connection. On reaching the prescribed tightening torque, the screw connection is sealed axially by the resulting surface pressure.

The sealings are used for the sealing of threaded connections at measuring locations and connection elements in apparatus and pipeline construction (e.g. valves, cocks, syphons, connection adapters, overpressure protectors).

Sealings prevent the accidental leakage of gaseous or liquid media into the environment.

It is recommended that, on each disassembly, the sealing is checked for damage or deformation and, if necessary, it is replaced.

Design forms

■ Form 1

For internal centring using centring spigot per EN 837-1

■ Form 2

For external centring in the threaded hole, intended for threaded spigots without centring spigots and without sealing lug

Installation example

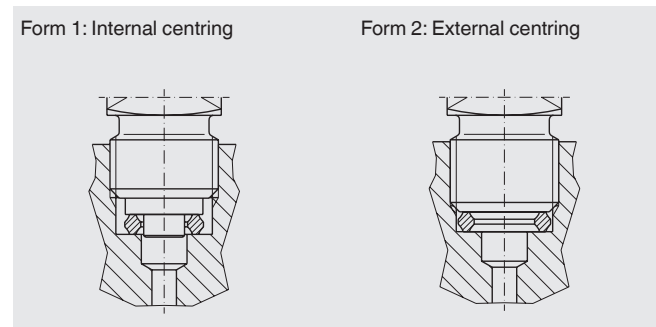

WIKA sealing

In addition to the proper sealing function, the WIKA sealing enables the easy alignment of instruments and instrumentation accessories to a desired position.

Traditional flat gaskets have the disadvantage that either the instrument or the valve does not end up in the desired reading direction or operating position, or that no sealing is achieved in the ideal position.

WIKA sealings avoid the unscrewing, repeated changing and placing of other flat sealings in different thicknesses, which is otherwise needed.

With the WIKA sealing it is possible, once the tightness has been achieved, to turn the part being aligned approximately 1 more rotation to the desired position.

WIKA sealings from stainless steel, as a result of their higher strength and specific form, achieve a high pressure tightness, even at low tightening torques. The version in stainless steel can then only be turned approximately another ½ rotation.

Dimensions in mm

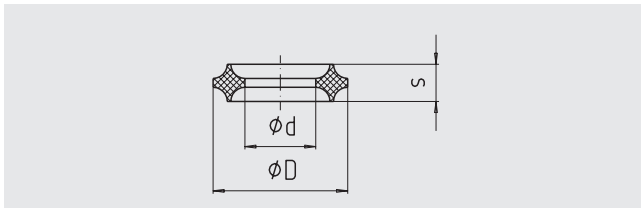

Version	For thread	Material	Dimensions in mm			Form	Order number
			D +0.2	d -0.2	s		
	G 1/8	Cu	8 + 0.1	4.1 + 0.1	2.7	1	9090789
	G 1/4, M12 x 1.5	Al	9.3	5.4	3.2	1	9090797
	G 1/4, M12 x 1.5	Cu	9.3	5.4	3.2	1	9090800
	G 1/4, M12 x 1.5	1.4571	9.3	5.4	3.2	1	9092161
	G 3/8, G 1/2, M20 x 1.5	Cu	14.8	8	4.2	1	9090819
	G 3/8, G 1/2, M20 x 1.5	1.4571	14.8	8	4.2	1	9092099
	G 1/4	Al	11	5.5	3.2	2	9092269
	G 1/4	Cu	11	5.5	3.2	2	9092277
	M12 x 1.5	Cu	9.8	5.5	3.2	2	9092285
	G 1/2	Cu	18.2	11	4.2	2	9092293

Flat sealing rings per EN 837-1 (and similar)

The dimensions of the sealing rings are harmonised with the EN 837-1 connection standard. The sealing rings are available in copper (Cu), nickel (Ni), asbestos-free Novapress 300 sealing material (NP uni) and plastic (PTFE).

The PTFE flat sealing ring with 0.5 mm thickness is suitable for the mounting of diaphragm pressure gauges with threaded connections and for the option "wetted parts from PTFE". If metal sealings are used, there is a risk of the PTFE lining being damaged.

The 2.0 mm thick PTFE sealing ring is mainly used for instruments and diaphragm seals for the food industry, with which the wetted parts are generally from stainless steel.

Dimensions in mm

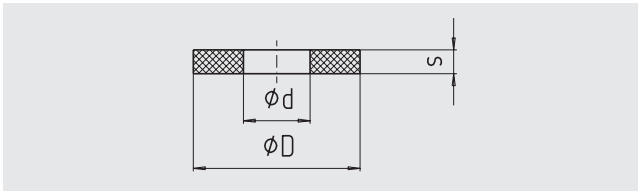

Version	For thread	Material	Dimensions in mm			Order number
			D	d	s	
	G 1/4 ¹⁾	Cu	9.5	5.2	1.5	9091424
	G 1/4 ¹⁾	NP uni	9.5	5.2	1.5	9091432
	G 1/2 ¹⁾	Cu	17.5	6.2	2	9091440
	G 1/2	NP uni	17.5	6.2	2.5	9091459
	G 1/2 ¹⁾	Ni	17.5	6.2	2	9091467
	G 1/4	PTFE	9.5	5.2	0.5	9092080
	G 1/2	PTFE	17.5	6.2	0.5	9091173
	G 1/2	PTFE	17.5	7	2	9091505

1) corresponds to EN 837-1

Edge sealing rings

Edge sealing rings are commonly used in conjunction with solderless compression fittings with compression rings and are included in the scope of delivery. The edge sealing rings offered here are mainly intended as replacement parts.

Dimensions in mm

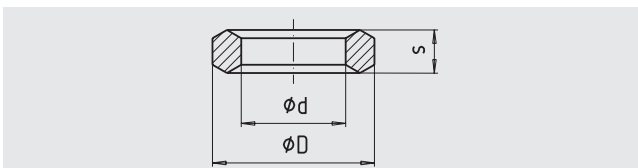

Version	For thread	Material	Dimensions in mm			Order number
			D	d	s	
	G 1/4	St	11.3	6	4.5	9092234
	G 1/2	St	18.5	12	5	9092242
	G 1/2	1.4571	18.5	12	5	9092250